

T01000-S_LE WORKOUT PICCOLO IN ALLUMINIO

T01000-S_LE SMALL ALUMINIUM WORKOUT

VISTA TRIDIMENSIONALE

THREE-DIMENSIONAL VIEW

SCHEMA TECNICA (TECHNICAL DATA SHEET)		
ART. T01000-S_MET	08-04-2019	SCALA (SCALE)
LE MISURE SONO ESPRESSE IN MM. (MEASUREMENTS ARE EXPRESSED IN MM.)		
	TOFFOLI GIOCHI SRL VIA BENEDETTO CROCE 7, Z.I. "CONDOTTI BARDINI", 31058 SUSEGANA (TV) 0438-460645	
	<small>Ci riserviamo a termini di Legge la proprietà di questo disegno con divieto di renderlo comunque noto a terzi senza la nostra approvazione. We reserve the right to read the ownership of this design with the prohibition of making it known to third parties without our approval.</small>	FOGLIO 1 DI 5

PIANTA (PLAN)

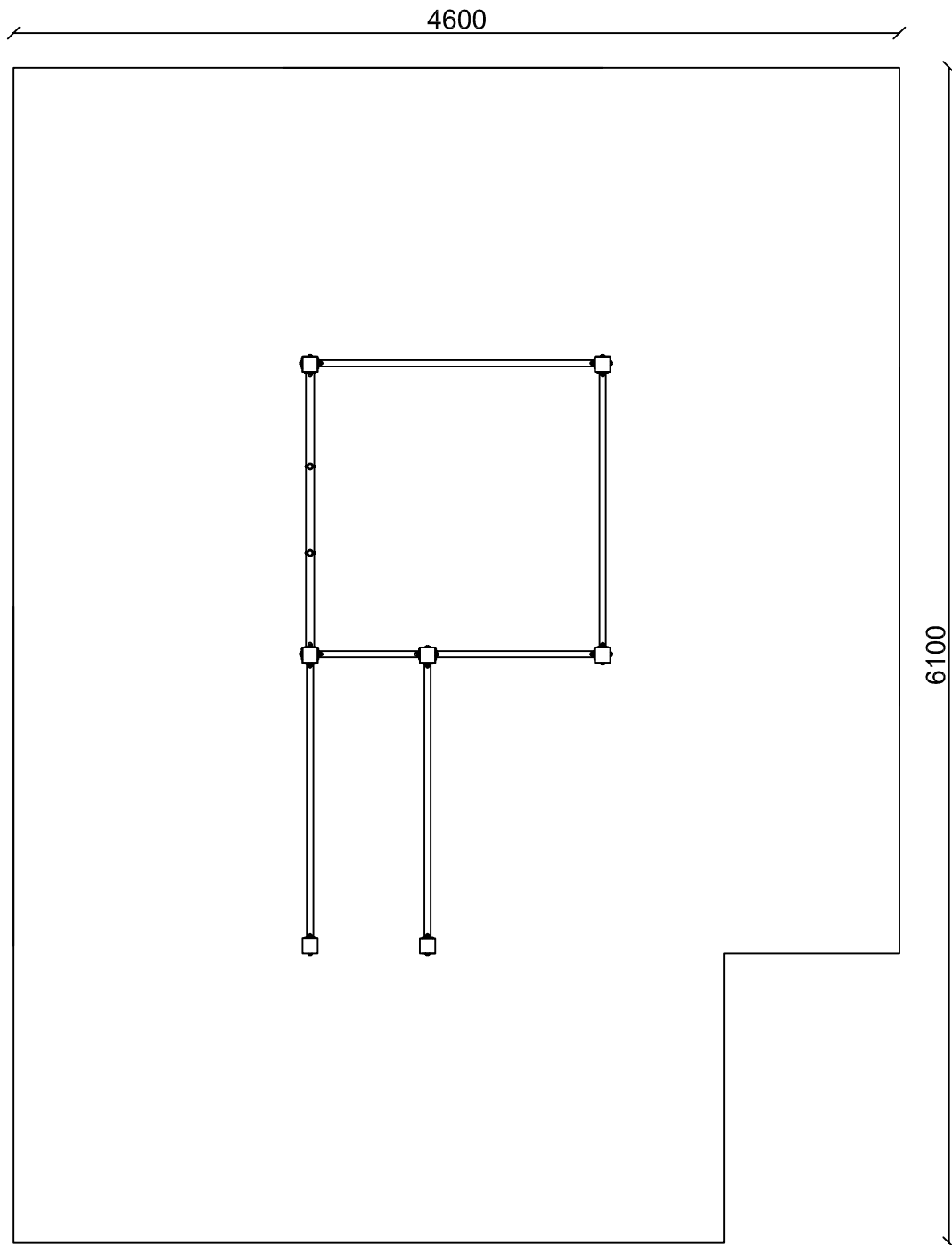

AREA DI SICUREZZA (SAFETY AREA) 26,7MQ

SCHEMA TECNICA (TECHNICAL DATA SHEET)		
ART. T01000-S_MET	08-04-2019	SCALA (SCALE) 1:35
LE MISURE SONO ESPRESSE IN MM. (MEASUREMENTS ARE EXPRESSED IN MM.)		
	TOFFOLI GIOCHI SRL VIA BENEDETTO CROCE 7, Z.I. "CONDOTTI BARDINI", 31058 SUSEGANA (TV) 0438-460645	
	<small>Ci riserviamo a termini di Legge la proprietà di questo disegno con divieto di renderlo comunque noto a terzi senza la nostra approvazione. We reserve the right to read the ownership of this design with the prohibition of making it known to third parties without our approval.</small>	FOGLIO 2 DI 5

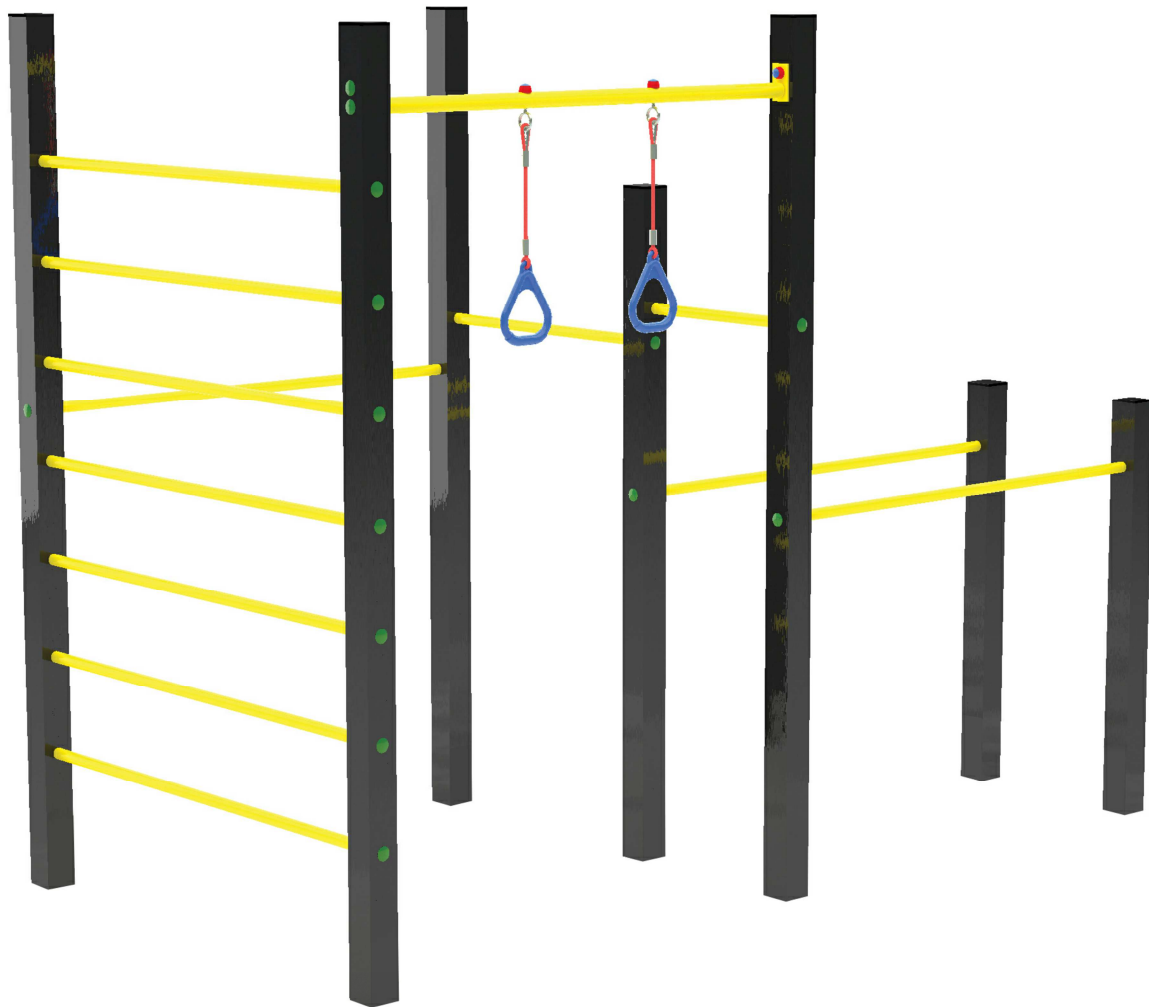

ALTEZZA DI CADUTA MAX. (SEAT HEIGHT)
212 cm



INGOMBRO (OVERALL DIMENSION)
1,60M X 3,10M X 2,52M H.



NUMERO UTILIZZATORI
(MAX N. OF SIMULTANEOUS USERS) 5



AREA DI SICUREZZA (IMPACT AREA)
4,60M X 6,10M

SCHEMA TECNICA (TECHNICAL DATA SHEET)

ART. T01000-S_MET

08-04-2019

SCALA (SCALE)

LE MISURE SONO ESPRESSE IN MM. (MEASUREMENTS ARE EXPRESSED IN MM.)

TOFFOLI
Giochi
Playgrounds for a playful world

TOFFOLI GIOCHI SRL
VIA BENEDETTO CROCE 7, Z.I. "CONDOTTI BARDINI", 31058 SUSEGANA (TV)
0438-460645

Ci riserviamo a termini di Legge la proprietà di questo disegno con divieto di renderlo comunque noto a terzi senza la nostra approvazione.
We reserve the right to read the ownership of this design with the prohibition of making it known to third parties without our approval

FOGLIO 3 DI 5

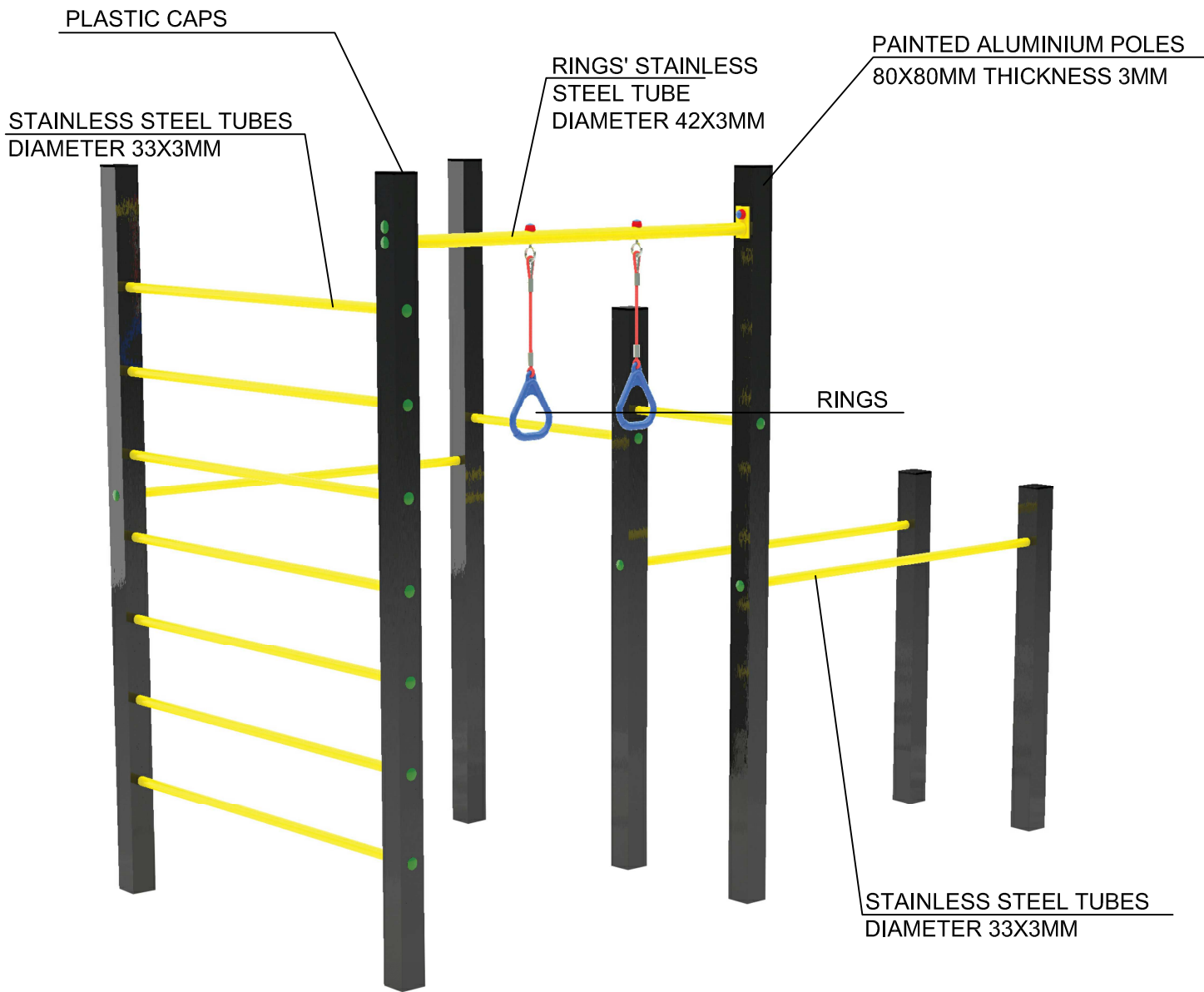

ALL THE FIXING ELEMENTS, SCREWS, DROWS, ECC .. ARE IN STAINLESS STEEL AND PROTECTED WITH PLASTIC BOLTS AND CAPS.

SCHEMA TECNICA (TECHNICAL DATA SHEET)

ART. T01000-S_MET

08-04-2019

SCALA (SCALE)

LE MISURE SONO ESPRESSE IN MM. (MEASUREMENTS ARE EXPRESSED IN MM.)



TOFFOLI GIOCHI SRL
VIA BENEDETTO CROCE 7, Z.I. "CONDOTTI BARDINI", 31058 SUSEGANA (TV)
0438-460645

Ci riserviamo a termini di Legge la proprietà di questo disegno con divieto di renderlo comunque noto a terzi senza la nostra approvazione.
We reserve the right to read the ownership of this design with the prohibition of making it known to third parties without our approval.

FOGLIO 4 DI 5

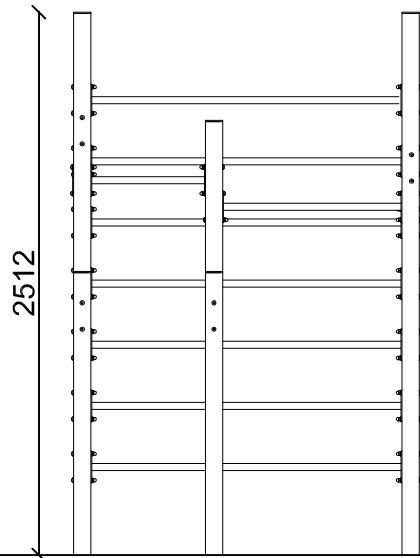

VISTA FRONTALE
(FRONTAL VIEW)

1600

VISTA LATERALE
(LATERAL VIEW)

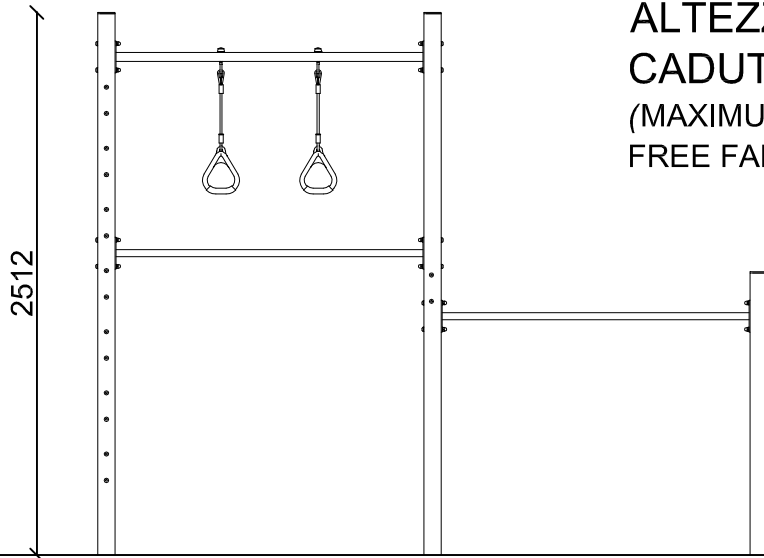

ALTEZZA MASSIMA DI
CADUTA LIBERA
(MAXIMUM HEIGHT OF THE
FREE FALL) CM 212

3100

INGOMBRO MAX (OVERALL DIMENSIONS)

SCHEDA TECNICA (TECHNICAL DATA SHEET)		
ART. T01000-S_MET	08-04-2019	SCALA (SCALE) 1:35
LE MISURE SONO ESPRESSE IN MM. (MEASUREMENTS ARE EXPRESSED IN MM.)		
	TOFFOLI GIOCHI SRL VIA BENEDETTO CROCE 7, Z.I. "CONDOTTI BARDINI", 31058 SUSEGANA (TV) 0438-460645	
	<small>Ci riserviamo a termini di Legge la proprietà di questo disegno con divieto di renderlo comunque noto a terzi senza la nostra approvazione. We reserve the right to read the ownership of this design with the prohibition of making it known to third parties without our approval.</small>	FOGLIO 5 DI 5